

# Jewelry Balances

## JL-G, JL-G/L Models



**METTLER TOLEDO**

# Operating instructions in a nutshell

Press key **briefly**

Press and **hold key down** until the desired display appears

▼ automatic sequence

\* These functions must be activated in the menu (section 4.3.2)

## Switching on

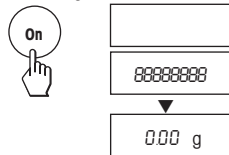

## Switching off



## Simple weighing

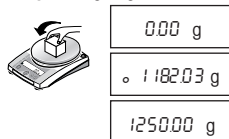

## Adjusting (calibration)

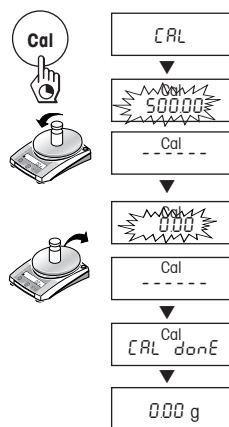

## Unit switching\*



## Piece counting\*

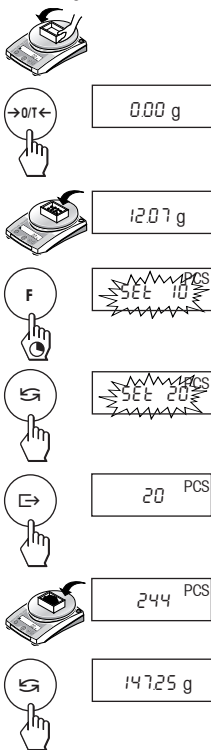

## Percent weighing\*

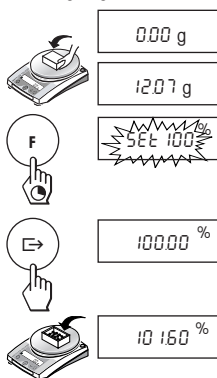

## Free factor / selectable display increment\*

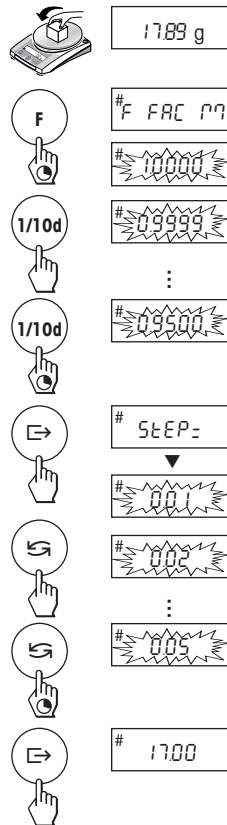

## Taring

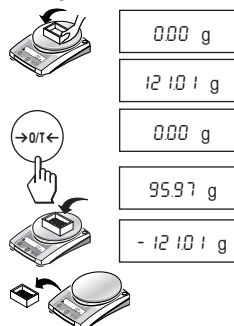

**Contents**

<b>1 Getting to know Jewelry balances JL.....</b>	<b>4</b>	<b>5 Functions .....</b>	<b>15</b>
1.1 General .....	4	5.1 Piece counting .....	15
1.2 Layout of balances .....	4	5.2 Percent weighing .....	16
1.3 Overview of key functions .....	5	5.3 Switching weight units .....	16
<b>2 Startup .....</b>	<b>6</b>	5.4 Weighing with free factor and/or selectable display increments .....	17
2.1 Unpacking / standard equipment.....	6	<b>6 Technical data, options, optional equipment ..</b>	<b>18</b>
2.2 Cautionary notes .....	6	6.1 Technical data .....	18
2.3 Setting up, leveling, preparations for weighing below the balance .....	6	6.2 RS232C interface .....	19
2.4 Adjusting (calibration) .....	8	6.3 MT-SICS Interface commands and functions .....	19
<b>3 Weighing .....</b>	<b>9</b>	6.4 Optional equipment .....	21
3.1 On/Off switching.....	9	6.5 Dimensional drawings (in mm) .....	22
3.2 Simple weighing .....	9	<b>7 Appendix .....</b>	<b>23</b>
3.3 Faster weighing with reduced readability .....	9	7.1 Typical printouts from METTLER TOLEDO RS-P28 printer .....	23
3.4 Taring .....	9	7.2 What if ...? .....	24
<b>4 Menu.....</b>	<b>10</b>	7.3 Maintenance and cleaning .....	25
4.1 Overview .....	10		
4.2 Menu operation .....	11		
4.3 Description of menu options .....	11		

**1 Getting to know Jewelry balances JL**

**1.1 General**

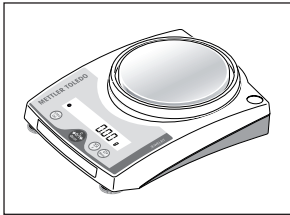

**Balance features**

- Readability 0.01 g to 0.1 g, max. load 610 g to 6100 g.
- In addition to basic operations such as **weighing, taring** and **adjusting** (calibration) miscellaneous functions such as **“Piece counting weighing”, “Percent weighing”** or **“Free factor”** can be activated.

**Note**

All models are available as certified versions. Please ask your METTLER TOLEDO dealer for details.

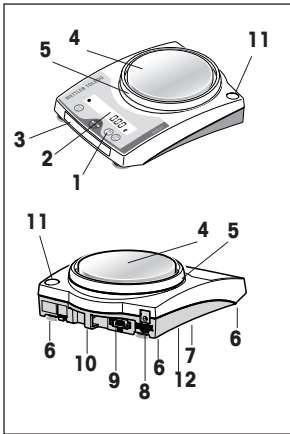

**1.2 Layout of balances**

- 1 Keys
- 2 Display
- 3 Model plate with the following data:
  - “Max”: maximum capacity
  - “d”: readability
  - “Min”: minimum capacity (recommended minimum load, **only relevant for certified balances**)
  - “e”: verification scale interval (smallest display increment tested during certification, **only relevant for certified balances**)
- 4 Weighing pan
- 5 Draft shield element (JL602-G/L)
- 6 Leveling feet
- 7 Hanger opening for weighing below the balance (underside of balance)
- 8 AC adapter socket
- 9 RS232C interface
- 10 Lug for optional antitheft device
- 11 Leveling control
- 12 Compartment for batteries

### 1.3 Overview of key functions

The balances have two operator control levels: the **weighing mode** and the **menu**. The function of each individual key depends on the operator control level and how long the key is pressed.

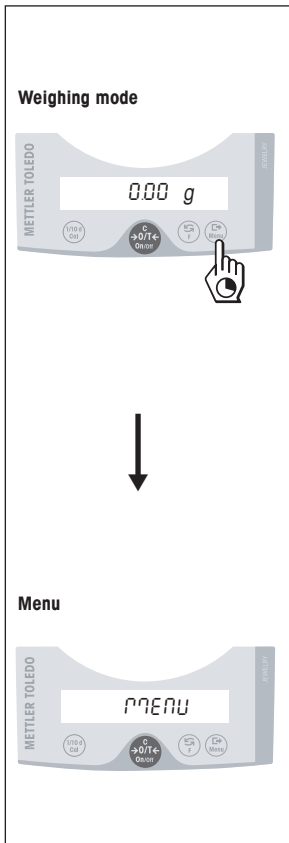

Key functions in weighing mode	
Press briefly	Press and hold down
<b>1/10d</b> <ul style="list-style-type: none"> <li>Reduce readability</li> </ul>	<b>Cal</b> <ul style="list-style-type: none"> <li>Adjust (calibrate)</li> </ul>
<b>On</b> <b>→0/T←</b> <b>C</b> <ul style="list-style-type: none"> <li>Switch on</li> <li>Zero/tare</li> <li>Cancel function</li> </ul>	<b>Off</b> <ul style="list-style-type: none"> <li>Switch off</li> </ul>
<ul style="list-style-type: none"> <li>Switch</li> <li>Change settings</li> </ul>	<b>F</b> <ul style="list-style-type: none"> <li>Call function; A function must be activated in the menu, otherwise "F nonE" appears in the display</li> </ul>
<ul style="list-style-type: none"> <li>Transfer weighing data via interface with activated printer</li> <li>Confirm settings</li> </ul>	<b>Menu</b> <ul style="list-style-type: none"> <li>Show menu (hold key down until MENU appears)</li> </ul>

Key functions in menu mode	
Press briefly	Press and hold down
<b>1/10d</b> <ul style="list-style-type: none"> <li>Change settings</li> <li>Reduce value by 1 step</li> </ul>	<b>1/10d</b> <ul style="list-style-type: none"> <li>Reduce value rapidly</li> </ul>
<b>C</b> <ul style="list-style-type: none"> <li>Close menu (without saving changes)</li> </ul>	–
<ul style="list-style-type: none"> <li>Change settings</li> <li>Increase value by 1 step</li> </ul>	<ul style="list-style-type: none"> <li>Increase value rapidly</li> </ul>
<ul style="list-style-type: none"> <li>Select next menu item</li> </ul>	<b>Menu</b> <ul style="list-style-type: none"> <li>Save changes and close menu</li> </ul>

## 2 Startup

### 2.1 Unpacking / standard equipment

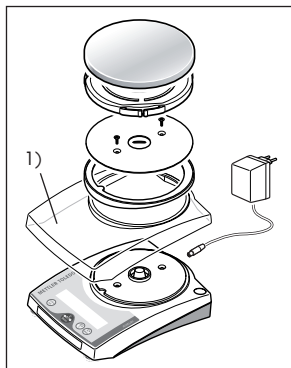

The standard equipment for every balance comprises:

- **AC adapter**, to national standard
- **Weighing pan, Weighing pan support, draft shield element**
- **Operating Instructions**
- **Protective cover** (placed on the balance over the weighing cell cone) with instruction sheet. **This protective cover must not be mislaid. It will be needed again later to protect the cone when changing batteries (underside of balance).**

1) In-use covers are available as optional extras (Section 6.4).

### 2.2 Cautionary notes



- JL balances must **not** be operated in **hazardous areas** with the standard-supply AC adapter.
- Before connecting the AC adapter, verify that the voltage printed on it corresponds to the local AC power supply voltage. If this is not the case, please contact your local METTLER TOLEDO dealer.
- JL balances may only be used indoors in a dry environment.
- For use with CSA Certified (or equivalent approved) power source, which must have a limited and SELV circuit output.

### 2.3 Setting up, leveling, preparations for weighing below the balance

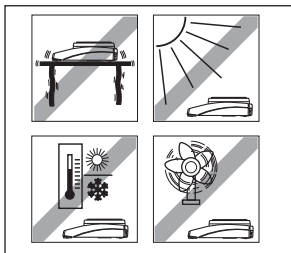

#### The optimum location

The correct location makes an important contribution to the accuracy of the weighing results of high-resolution analytical and precision balances.

- Stable, vibration-free position as horizontal as possible
- No direct sunlight
- No excessive temperature fluctuations
- No drafts

The best location is on a stable bench in a corner protected against drafts, as far away as possible from doors, windows, radiators or the louvers of air conditioners.

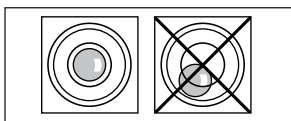

#### Leveling

Some models are equipped with a level glass and two or four leveling feet to compensate for minor irregularities in the surface on which the balance stands. The balance is exactly horizontal when the air bubble is in the middle of the level glass.

**Note:** The balance should be leveled each time it is moved to a new location.

#### Preparations for weighing below the balance

To carry out weighing operations below the balance, get rid of the special cover on the underside of the balance. (**Note: never put the balance without the protective cover over its cone down on its head, only on its side!**). This exposes the opening for the hanger, making weighing below the balance possible.

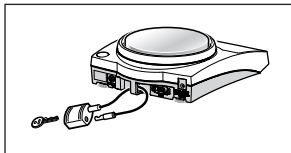

### Anti-theft device

All models are provided with a lug for attaching an anti-theft device (see optional equipment in Section 6.4).

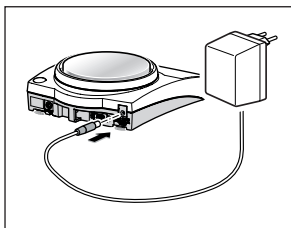

### Power supply

- Plug the AC adapter into the AC adapter socket on the balance, and connect to the power supply.
- The balance performs a self-test. This test is finished when "OFF" appears.
- Press the «On» key briefly: the balance is in operational readiness. Before any work is performed with the balance, it must be adjusted (Section 2.4).

### Battery operation

Models in the JL line of balances can also be operated independently of the AC power supply by using their batteries. To do this, **always fit the protective cover over the weighing cell cone first**, then open the cover of the battery compartment on the underside of the balance and insert the batteries.

**Caution: ensure correct polarity** (as specified inside the battery compartment).

Close battery compartment again.

When the balance is operating on its batteries, the border around the battery symbol in the display lights up. The number of segments that are lit is an indicator of battery condition (3 = fully charged, 0 = discharged). When the batteries are almost completely discharged, the last segment flashes.

**Recommended battery type:** AA (LR6) 1.5 V alkali-manganese.

NiMH (nickel-metal hydride) rechargeable batteries, which are recharged in an external battery charger, can be also be used. The intervals between recharging are not as long as the service life of a nonrechargeable battery.

### Notes

- Batteries are not included in the standard supply.
- Battery operation is automatically overridden when the AC adapter is connected to the AC power supply.
- To prolong battery (disposable or rechargeable) life, it is advisable to activate «Auto shut» in the menu (see Section 4.3.7).
- All discharged batteries must be disposed of in an environmentally responsible manner. No attempt must be made to incinerate or disassemble them.



## 2.4 Adjusting (calibration)

To obtain accurate weighing results, the balance must be adjusted to match the gravitational acceleration at its location.

### Adjusting is necessary

- before the balance is used for the first time
- at regular intervals during weighing service
- after a change of location

To obtain accurate results, the balance must be left switched on for 30 minutes to reach operating temperature before starting the adjustment procedure.

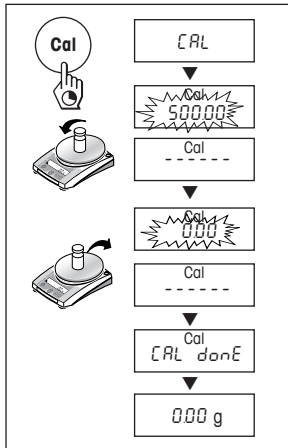

### Adjusting with external weight

- Have required adjusting weight ready.
- Unload weighing pan.
- Press and hold the «Cal» key down until "CAL" appears in the display. Release key.

The required adjustment weight value flashes in the display.

- Place adjustment weight in centre of pan. The balance adjusts itself automatically.

- When "0.00 g" flashes, remove adjustment weight.

The adjusting is finished when the message "CAL done" appears briefly in the display, followed by "0.00 g". The balance is again in weighing mode and ready for operation.

### Notes

- **Certified models cannot** be adjusted by the user, because of weights and measures legislation.
- This adjustment procedure can be terminated at any time with the «C» ("Cancel") key. The balance reverts to weighing mode.



### 3 Weighing

#### 3.1 On/Off switching

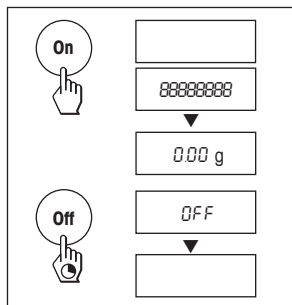

##### Switching on

- Remove any load from weighing pan and press «On» key briefly. The balance performs a display test (all segments in the display light up briefly). When zero is displayed, the balance is ready for operation.

##### Switching off

- Press and hold the «Off» key down until "OFF" appears in the display. Release the key.

#### 3.2 Simple weighing

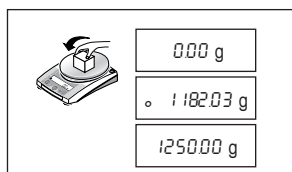

- Place weighing sample on the weighing pan.
- Wait until the stability detector "o" disappears.
- Read the result.

#### 3.3 Faster weighing with reduced readability

The balance has the facility for speeding up the weighing operation by reducing its readability (number of decimal places):

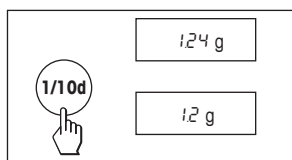

- The balance is operating with its **normal readability and speed**.
- Press the «1/10d» key and ...
- ... the balance operates with reduced readability (one decimal place less), but displays the weighing result quicker. Pressing the «1/10d» key briefly again toggles the balance back to its full readability.

#### 3.4 Taring

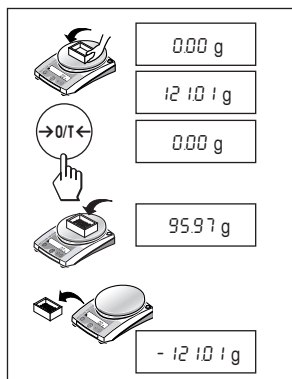

- Place empty container on the balance.
- The weight is displayed.
- Press the «→0/T←» key briefly.
- Add weighing sample to container. The net weight is now displayed.

If the container is removed from the balance, the tare weight will be shown as a negative value.

The tare weight remains stored until the «→0/T←» key is pressed again or the balance is switched off.

4 Menu

4.1 Overview

In the menu you can change the weighing unit, select additional functions and carry out various settings. A description of the individual menu options is given in Section 4.3.

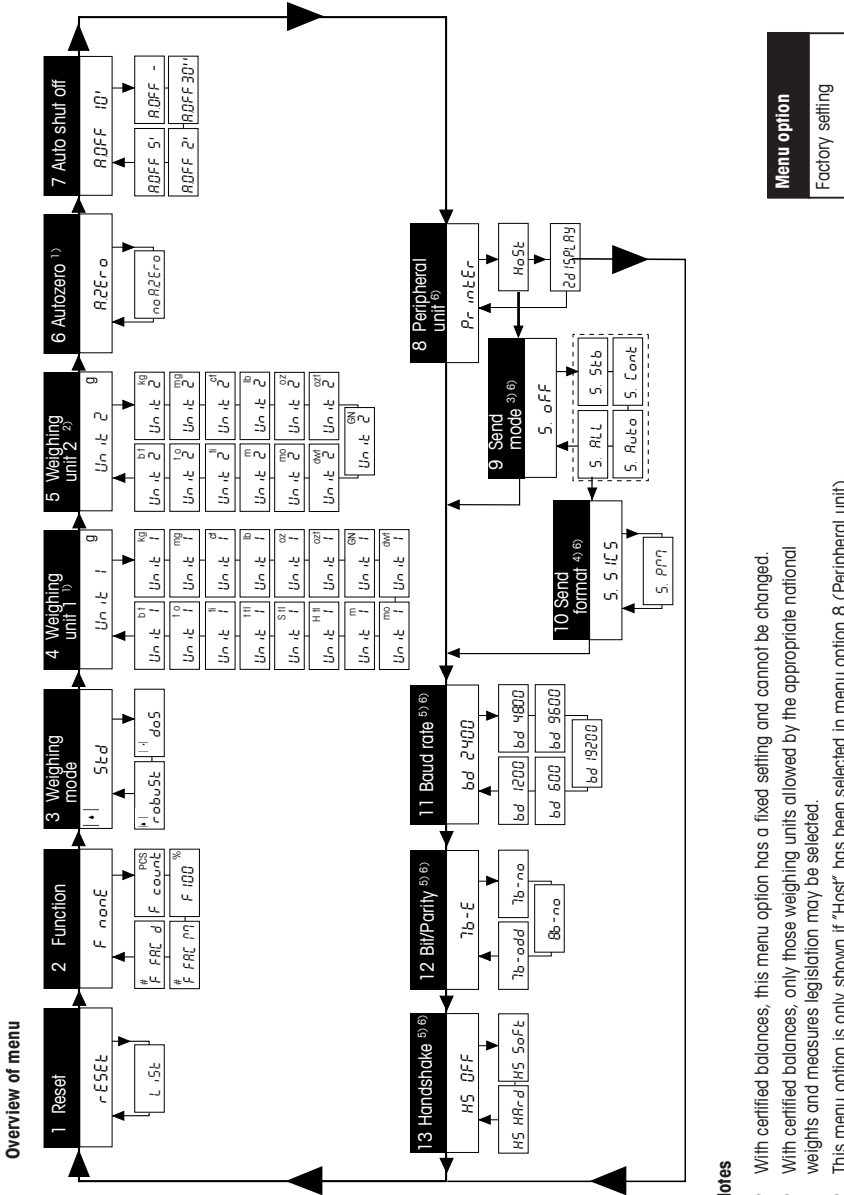

**Menu option**  
Factory setting

- Notes**
- 1) With certified balances, this menu option has a fixed setting and cannot be changed.
  - 2) With certified balances, only those weighing units allowed by the appropriate national weights and measures legislation may be selected.
  - 3) This menu option is only shown if "Host" has been selected in menu option 8 (Peripheral unit).
  - 4) This menu option is only shown if "S.oFF" has not been selected in menu option 9 (Send mode).
  - 5) These menu options are only shown if "Host" or "Printer" has been selected in menu option 8 (Peripheral unit).
  - 6) Only displayed if an interface has been installed.

## 4.2 Menu operation

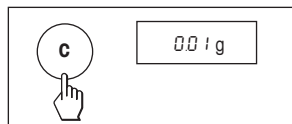
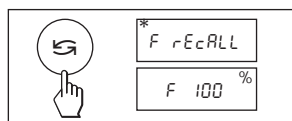
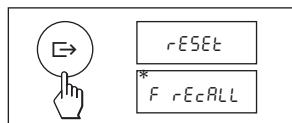
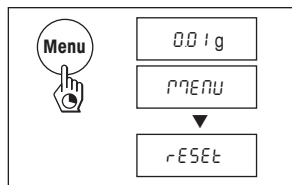

### Opening the menu

In weighing mode, press and hold down the «Menu» key until "MENU" appears in the display. Release the key: the 1st menu option is displayed.

### Select menu options

The « $\rightarrow$ » key is used to select individual menu options with their current settings one after the other.

### Change settings

Pressing the « $\leftarrow$ » key displays the next setting; pressing the «1/10d» key displays the previous one. Once the desired setting appears in the display, the next menu option can be selected (« $\rightarrow$ ») or you can close the menu (see following Section).

### Saving settings and closing the menu

Hold the «Menu» key down until "StorEd" appears in the display. Release the key and the balance reverts to weighing mode. All changes are saved.

### Abort

Press the «C» key briefly. The balance reverts to weighing mode. Changes are **not** saved.

### Note

If no entry is made within 45 seconds, the balance reverts to weighing mode. Changes are **not** saved.

## 4.3 Description of menu options

### 4.3.1 Reset or recording of balance settings (1st menu option "RESET")



#### Reset balance settings

→ Select "Reset", press and hold down the «Menu» key until the message "r donE" confirms that all menu settings have been reset. The balance then reverts to weighing mode and works with the factory settings (Section 4.1).

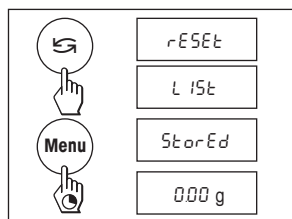

#### Recording balance settings

→ Select "List" and hold down the «Menu» key until the message "StorEd" is displayed.

The current balance settings are transmitted to the peripheral device connected to the optional RS232C interface. To do this the setting "Printer" must always be selected at the 8th menu option (Peripheral unit). The current balance settings are saved at the same time.

**4.3.2 Functions (2nd menu option / see Section 5 for their use)**

In addition to simple weighing, the following functions can be selected with the «↶» key:

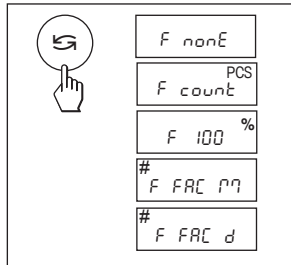

- F nonE No function, simple weighing
- F count Piece counting
- F 100 % Percent weighing
- F FAC M Multiply free factor value by weight, change size of display increment
- F FAC d Divide free factor value by weight, change size of display increment

**4.3.3 Weighing mode (3rd menu option)**

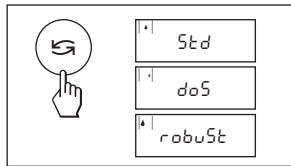

This setting allows you to adapt the balance to the weighing mode. Select "Std" (standard) for all normal weighing processes. With "doS" (dosing) - for dispensing substances in liquid or powder form - the balance reacts very rapidly to the slightest changes of weight. With "robuSt" (absolute weighing) the balance only reacts to more significant changes in weight, so that the weighing result is very stable.

**4.3.4 Weighing unit 1 (4th menu option "UNIT 1")**

Depending on requirements, the balance can operate with the following units (possible with certified balances only if permitted by national weights and measures legislation):

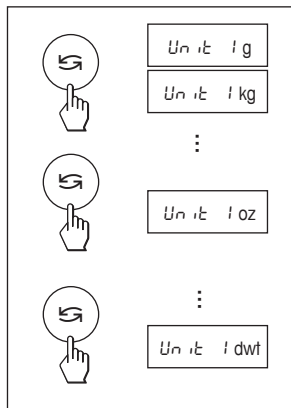

Unit	Conversion factor	Comments
g	gram	factory setting
kg	kilogram	1 kg = 1000 g
mg	milligram	1 mg = 0,001 g
ct	carat	1 ct = 0,2 g
lb	pound	1 lb = 453,59237 g
oz	ounce	1 oz = 28,349523125 g
ozt	troy ounce	1 ozt = 31,1034768 g
GN	grain	1 GN = 0,06479891 g
dwt	pennyweight	1 dwt = 1,55517384 g
mo	momme	1 mom = 3,75 g
m	Mesghal	1 msg ≈ 4,6083 g
H tl	Hong Kong tael	1 tlh = 37,429 g
S tl	Singapore tael	1 tfs ≈ 37,7993641666667 g
t tl	Taiwan tael	1 t tl = 37,5 g
cl	Tical	1 tical ≈ 16,3293 g
fo	tola	1 tola = 11,6638038 g
bt	baht	1 baht = 15,16 g

The Malaysian tael has the same value

**4.3.5 Weighing unit 2 (5th menu option "UNIT 2")**

If it is required to show the weighing result in weighing mode in an additional unit by pressing the «↶» key, the desired second weighing unit can be selected in this menu option. The same weighing units are available as under "UNIT 1", with the exception of the tael units ("H tl", "S tl" and "t tl").

#### 4.3.6 Autozero (6th menu option / see overview and notes in Section 4.1)

This menu option allows you to switch the automatic zero correction on or off.

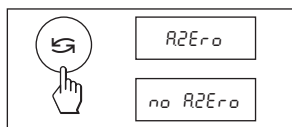

##### Autozero switched on

The zero point is automatically corrected (e.g. if drift occurs or the weighing pan becomes dirty).

##### Autozero switched off

The zero point is **not** automatically corrected. This setting is advantageous for special applications (e.g. evaporation measurements).

#### 4.3.7 Auto shut off (7th menu option)

If the automatic shut off function is activated, the balance automatically switches itself off after a selected period of inactivity (i.e. with no key being pressed or changes of weight occurring):

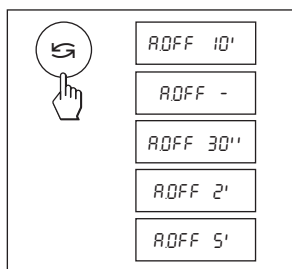

A.OFF 10'	Automatic shutoff after 10 minutes inactivity
A.OFF -	Automatic shutoff <b>not</b> activated
A.OFF 30"	Automatic shutoff after 30 seconds inactivity
A.OFF 2'	Automatic shutoff after 2 minutes inactivity
A.OFF 5'	Automatic shutoff after 5 minutes inactivity

#### 4.3.8 Peripheral unit (8th menu option / see overview and notes in Section 4.1)

Peripheral devices can only be connected if the balance has been equipped with an RS232C interface. The balance automatically saves the appropriate settings (Sections 4.3.9 – 4.3.13) for every peripheral device.

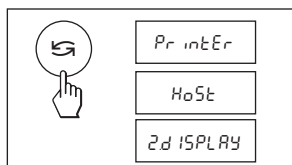

Printer	Connected to a printer.
Host	Connection to any desired peripheral device.
Aux. display	Connection of an optional auxiliary display unit (communications parameters cannot be selected).

#### 4.3.9 Send mode (9th menu option / see overview and notes in Section 4.1)

**Note:** This menu option is only available if the "Host" setting was selected in the 7th menu option (Peripheral unit)!

It specifies how a value is transferred to a peripheral device.

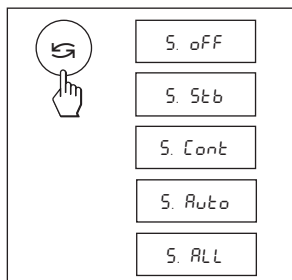

S. oFF	Send mode switched off.
S. Stb	The next possible stable value will be transferred after the « $\square$ » key has been pressed.
S. Cont	All values are transferred automatically.
S. Auto	Only stable values are transferred automatically.
S. All	The current value is transferred after the « $\square$ » key has been pressed.

**4.3.10 Send format (10th menu option / see overview and notes in Section 4.1)**

**Note:** This menu option is only available if the "S. oFF" setting was **not** selected in the 9th menu option ("Send mode")!

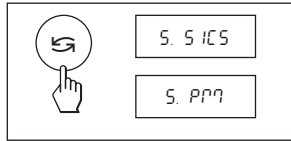

It sets the data transfer format.

"S. SICS": The MT-SICS data transfer formats are used. Please refer to the "Reference Manual MT-SICS B-S/L/L-S balances 11780447", available from your METTLER TOLEDO dealer or downloaded from the Internet ([www.mt.com/sics-classic](http://www.mt.com/sics-classic)).

More Information please find in the Section 6.3.

"S. PM\*": The following PM balance data transfer formats are used:

- S. Stb: `SDUUU1.67890Lg`
- S. Conf: `SDUUU1.67890Lg SDUUU1.39110Lg`
- S. Auto: `SDUUU1.67890Lg`
- S. All: `SDUUU1.67890Lg`  
`LDUUU1.39110Lg`

\* unidirectional, no MT-SICS commands are accepted.

**4.3.11 Baud rate (11th menu option / see overview and notes in Section 4.1)**

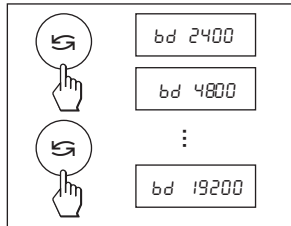

**Note:** This menu option is only available if the "Printer" or "Host" setting was selected in the 8th menu option (Peripheral unit)!

The baud rate (data transfer rate) determines the speed of transmission via the serial interface. The unit is the baud (bd) = 1 bit/second.

The following settings are available: 600 bd, 1200 bd, 2400 bd, 4800 bd, 9600 bd and 19200 bd.

For problem-free data transmission the sending and receiving devices must be set at the same value.

**4.3.12 Bit/Parity (12th menu option / see overview and notes in Section 4.1)**

**Note:** This menu option is only available if the "Printer" or "Host" setting was selected in the 8th menu option (Peripheral unit)!

It sets the character format for the peripheral device connected to the balance.

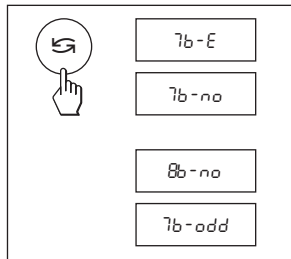

- 7b-E 7 data bits/even parity
- 7b-no 7 data bits/no parity
- 8b-no 8 data bits/no parity
- 7b-odd 7 data bits/odd parity

**4.3.13 Handshake (13th menu option / see overview and notes in Section 4.1)**

**Note:** This menu option is only available if the "Printer" or "Host" setting was selected in the 8th menu option (Peripheral unit)!

This function is used to select the data transfer mode to suit different serial devices.

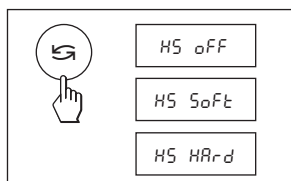

- HS oFF No handshake
- HS SoFt Software handshake (XON/XOFF)
- HS HArD Hardware handshake (RTS/CTS)

**5 Functions**

Settings and values saved under a given function are retained until they are replaced or another function is selected. The «C» key can be used to cancel the procedure currently in progress.

**5.1 Piece counting**

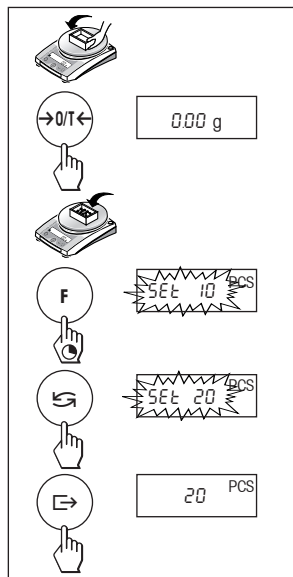

**Requirement**

The function "F count" must be activated in the menu (Section 4).

→ Place empty container on the balance and tare by briefly pressing the «→0/T←» key.

**Setting the reference:** a reference weight must first be entered for piece counting:

→ Add a number of reference pieces to container. Possible numbers are 5, 10, 20, 50, 100 and "no" (piece counting deactivates).

Note that the minimum weight = 10d (d: display increment), and the minimum unit weight = 1d!

→ Hold the «F» key down until "SET ... PCS" is displayed.

→ Repeatedly press the «5» key until the display equals the number of reference pieces entered.

→ Confirm the number of reference pieces with the «=>» key or automatic acceptance after 7 seconds. The current number of pieces (PCS = pieces) is displayed.

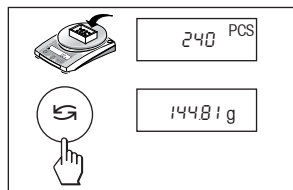

**Switching between piece count and weight display**

→ Place the items to be counted in the container. The number of pieces is displayed.

→ Press the «5» key. The weight is displayed (in unit 1, and if the key is pressed again, in unit 2, provided this function is activated).

→ Return to the piece count display by pressing the «5» key again.

5.2 Percent weighing

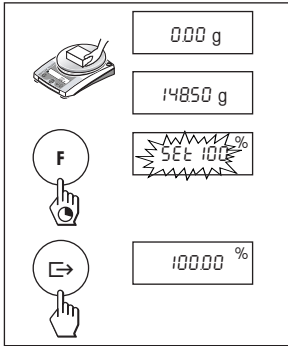

**Requirement**

The function "F 100 %" must be activated in the menu (Section 4).

**Set target weight**

→ Target weight (Reference weight, which corresponds to 100 %) in centre of pan.

Note that the minimum weight = 10d (d: display increment).

→ Hold the «F» key down until "SEt 100 %" is displayed.

→ Press the «E» key to select "SEt 100 %" or "SEt no %" (Percent weighing deactivated).

→ The «E» key can be used briefly to confirm or automatic acceptance after 7 seconds.

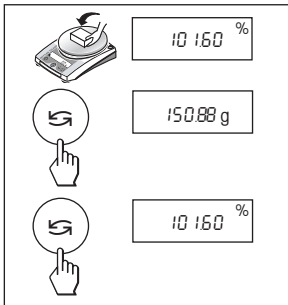

**Switching between percent weighing and weight display**

→ Place weighing sample in centre of pan.

The weight of the sample is displayed as a percentage of the target weight.

→ Press the «S» key. The weight is displayed.

→ Return to display in percent: pressing the «S» key again.

5.3 Switching weight units

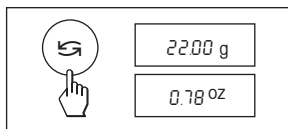

**Requirement**

Different weight units must be activated in the menu for unit 1 and unit 2 (Section 4).

→ The «S» key can be used at any time to toggle between the two weighing units selected in the menu ("UNIT 1" and "UNIT 2").

**Note**

- Switching between weight units may be blocked with **certified balances**, depending on national weights and measures legislation.



### 5.4 Weighing with free factor and/or selectable display increments

In this menu option a custom "free factor" can be defined at will.

This value is then either multiplied ("F FAC M") by the weighing result (in grams), i.e. reading = factor \* weight, or it is divided ("F FAC d") by the weight, i.e. reading = factor / weight. The range over which this factor can be selected depends on the weighing range and the readability of the model concerned.

The "free factor" (FAC M) function can, for example, be used to calculate the price of the material weighed directly or to calculate the weight per defined unit of surface area. It can also be used to convert the weight into any desired alternative unit. The ability to select the display increments makes it possible to specify how the weighing result is to be presented, the choice of display increments being limited by the set factor and the resolution of the balance model itself.

#### Requirement

The function "F FAC M" or "F FAC d" must be activated in the menu (Section 4).

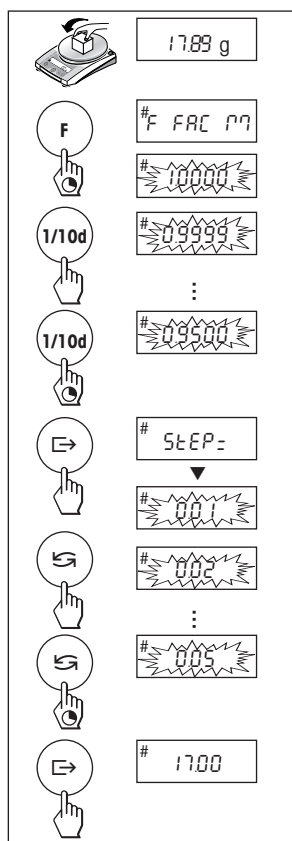

#### Entering the free factor and/or the display increments

- Hold the «F» key down until "F FAC M" or "F FAC d" appears in the display.
- Press the «StEP=» key to select "FAC M" / "FAC d" or "noFAC M" / "noFAC d" (Function deactivated).
- Release the key. Either the factor 1 appears as default value or the factor that was saved most recently.

This value can now be changed:

- Pressing the «StEP=» key increases the factor.
- Pressing the «1/10d» key reduces the factor.

Pressing the key once changes the value by one increment. If the key is held down, the value changes increasingly rapidly.

- Confirm the selected factor with the «±» key (it will not be saved automatically). "StEP=" appears in the display, and the program changes automatically to allow the display increments to be entered. The smallest possible display increment appears as default value, or the last value that was saved.
- This value can be changed in the same way as for the free factor (see above). Confirm the selected display increment with the «StEP=» key (it will not be saved automatically).

The appropriate calculation is then made using the weight on the pan in grams and the selected factor, the result being displayed with the selected display increment. **No units are displayed**, the symbol "#" being displayed instead. The calculation is always based on the weight in grams.

#### Note

- If you only want to change the display increments, set the free factor at exactly 1.

#### toggling between displaying the calculated value and the measured weight

- Place the sample on the weighing pan. The appropriate calculation is then made using the weight of the sample and the selected factor, the result being displayed with the selected display increment.
- Press the «StEP=» key. The weight is displayed (in unit 1, and if the key is pressed again in unit 2, provided that this option is activated).
- Press the «StEP=» key again to return to the calculated value.

**6 Technical data, options, optional equipment**
**6.1 Technical data**
**Standard equipment**

- AC adapter to national codes.  
100–240 VAC/50–60 Hz, 0.3 A  
12 VDC, 0.84 A  
Balance power input 6-14,5VAC, 50/60Hz, 4VA or  
7-20VDC, 4W
- Can weigh below balance

**Materials**

- Housing: plastic (ABS/PC)
- Weighing pan: 18/10 chromium-nickel steel

**Batteries**

- 4 x AA (LR6) 1.5 V alkali-manganese,  
typical 20 h (with 2.9 Ah capacity)

**Protection**

- Protected against dust and water
- Pollution degree: 2
- Installation category: class II
- EMC: see declaration of conformity

**Ambient conditions**

The technical data are valid under the following ambient conditions:

- Ambient temperature 10 °C ... 30 °C
- Relative humidity 10 % to 80 % at 31 °C,  
linear decreasing  
to 50 % at 40 °C  
noncondensing

Operability is assured at ambient temperatures between 5 and 40 °C.

	<b>JL602-G/L</b>	<b>JL1502-G</b>	<b>JL6001-G/L</b>
Max. capacity	610 g	1510 g	6100 g
Readability	0.01 g	0.01 g	0.1 g
Repeatability (sd)	0.01 g	0.01 g	0.1 g
Linearity	0.03 g	0.03 g	0.2 g
Sensitivity temperature drift (10 °C ... 30 °C)	±10 ppm/°C	±10 ppm/°C	±10 ppm/°C
Settling time, typical	3 s	3 s	3 s
Adjustment weight external (optional)	500 g	1000 g	5000 g
Interface	RS232C	RS232C	RS232C
External dimensions of balance (W/D/H)	194x225x67 mm	194x225x67	194x225x67
External dimensions of packaging (W/D/H)	350x275x140 mm (0.0127 m <sup>3</sup> )	350x275x140 (0.0127 m <sup>3</sup> )	350x275x140 (0.0127 m <sup>3</sup> )
Weighing pan	∅ 120 mm	∅ 160 mm	∅ 160 mm
Net weight (with packaging)	1.0 (2.1) kg	1.3 (2.3) kg	1.3 (2.3) kg
Level indicator	yes	yes	yes
Number of leveling screws	2	4	4
Certified balance available	yes	yes	yes

### 6.2 RS232C interface

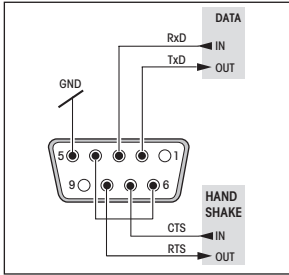

Every balance is equipped with an RS232C interface for connection to a peripheral device (e.g. printer, auxiliary display or PC with a 9-pin male connector, see Section 6.4). The balance must then be configured to suit the peripheral device in a menu dialog (Sections 4.3.8 – 4.3.13).

A detailed description of the available interface commands is given in the "Reference Manual MT-SICS B-S/L/L-S balances 11780447". This can be downloaded from the Internet ([www.mt.com/sics-classic](http://www.mt.com/sics-classic)) and is only available in English.

The wide range of features of the balances regarding documentation of the results can be utilized by connecting to a printer, e.g. the RS-P28 from METTLER TOLEDO. Printed results then make a decisive contribution to simplifying GLP/GMP-compliant work.

### 6.3 MT-SICS Interface commands and functions

Many of the balances used have to be capable of integration in a complex computer or data acquisition system. To enable you to integrate balances in your system in a simple manner and utilize their capabilities to the full, most balance functions are also available as appropriate commands via the data interface.

All new METTLER TOLEDO balances launched on the market support the standardized command set "METTLER TOLEDO Standard Interface Command Set" (MT-SICS). The commands available depend on the functionality of the balance.

#### Basic information on data interchange with the balance

The balance receives commands from the system and acknowledges the command with an appropriate response.

#### Command formats

Commands sent to the balance comprise one or more characters of the ASCII character set. Here, the following must be noted:

- Enter commands only in uppercase.
- The possible parameters of the command must be separated from one another and from the command name by a space (ASCII 32 dec., in this description represented as  $\_$ ).
- The possible input for "text" is a sequence of characters of the 8-bit ASCII character set from 32 dec to 255 dec.
- Each command must be closed by  $C_{n-F}$  (ASCII 13 dec., 10 dec.).

The characters  $C_{n-F}$ , which can be inputted using the Enter or Return key of most entry keypads, are not listed in this description, but it is essential they be included for communication with the balance.

#### Example

##### S – Send stable weight value

Command	S	Send the current stable net weight value.
Response	S $\_$ S $\_$ S $\_$ WeightValue $\_$ Unit	Current stable weight value in unit actually set under unit 1.
	S $\_$ I	Command not executable (balance is currently executing another command, e.g. taring, or timeout as stability was not reached).
	S $\_$ +	Balance in overload range.
	S $\_$ -	Balance in underload range.

#### Example

Command	S	Send a stable weight value.
Response	S $\_$ S $\_$ S $\_$ 100.00 $\_$ g	The current, stable weight value is 100.00 g.

The MT-SICS commands listed below is a selected list of available commands. For additional commands and further information please refer to the Reference Manual "MT-SICS for B-S/L/L-S balances 11780447" downloadable from the Internet under [www.mt.com/sics-classic](http://www.mt.com/sics-classic).

#### **S – Send stable weight value**

Command **s** Send the current stable net weight value.

#### **SI – Send value immediately**

Command **sI** Send the current net weight value, irrespective of balance stability.

#### **SIR – Send weight value immediately and repeat**

Command **SIR** Send the net weight values repeatedly, irrespective of balance stability.

#### **Z – Zero**

Command **z** Zero the balance.

#### **@ – Reset**

Command **@** Resets the balance to the condition found after switching on, but without a zero setting being performed.

#### **SR – Send weight value on weight change (Send and Repeat)**

Command **SR** Send the current stable weight value and then send continuously the stable weight value after every weight change.  
The weight change must be at least 12.5 % of the last stable weight value, minimum = 30d.

#### **ST – Send stable weight after pressing (transfer) key**

Command **sT** Inquiry of actual status of the ST function.

#### **SU – Send stable weight value with currently displayed unit**

Command **sU** As the "s" command, but with the currently displayed unit.

#### 6.4 Optional equipment

##### AC adapter

AC adapter universal (EU, USA, AU, UK) 11120270  
 100–240 VAC/50–60 Hz, 0.3 A  
 12 V DC, 0.84 A

##### Adjustment weights

Available as OIML weights (E1, E2, F1, with calibration certificate); for further details see [www.mt.com/weights](http://www.mt.com/weights)

##### Antitheft device

Cable with lock 00590101

##### Auxiliary display

- Auxiliary display RS-AD-L7, with backlit 72213564

##### Draft shield

Glass cylinder 12102988

##### Interface cable

- RS9–RS25: (m/f), length 2 m 11101052
- RS9–RS9: (m/f), length 1 m 11101051
- RS9–RS9: (m/m), length 1 m 21250066
- RS232–USB converter cable 11103691

##### In-use cover

12102980

##### PowerPac

PowerPac-M-12V, rechargeable external power source for mains independent operation of balances, 12 V DC/1 A 12122363

##### Printer, Application printer (RS-P28/11)

Plain-paper printer, 24 characters, with additional functions (time, date, statistic) 11124309

##### Software

LabX direct balance (software for easy data transfer to PC) 11120340

##### Transport case

For all models (without draftshield); accommodates balance, AC adapter, batteries and weights 12102982

6.5 Dimensional drawings (in mm)

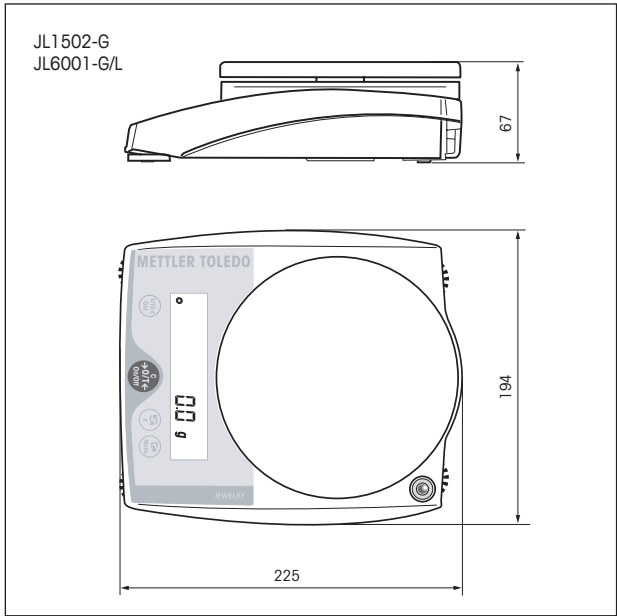
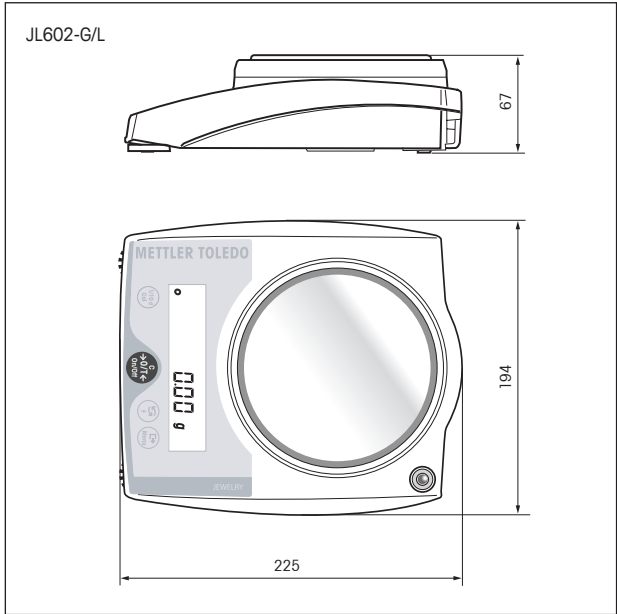

## 7 Appendix

### 7.1 Typical printouts from METTLER TOLEDO RS-P28 printer

#### Function: Adjusting

```

-BALANCE CALIBRATION-
04.07.2007      09:50:12

METTLER TOLEDO
Type:          JL602-G/L
SNR:          1120053108
SW:           1.0
Weight ID: .....
Weight:       500.00 g

External Cal. done

Signature:
.....
----- END -----

```

#### Function: Percent weighing

```

----- % - WEIGHING -----
Ref.      10.008 g
          100.00 %

          60.01 g
          599.59 %

```

#### Function: Piece counting Printout with reference weight

```

----- PIECE COUNTING -----
APW:      0.99 g
Out of:   10 PCS

          27.00 g
          27 PCS

```

#### Function: List

##### Printout of the current balance settings

```

--- LIST OF SETTINGS ---
04.07.2007      09:55:12

METTLER TOLEDO
Type:          JL602-G/L
SNR:          1120053108
SW:           1.0
TDNR:         7.17.1.286.108
-----
Weighing Parameters:
Weighing Mode Standard
Unit 1         g
A.Zero        On
-----
System Parameters:
Auto off      10 min
-----
Peripheral Devices:
P.Device      Printer
Baud         2400
Bit/Parity    7b-even
Handshake     Off

P.Device      Host
Sendmode     Off
Baud         9600
Bit/Parity    8b-no
Handshake     Soft
----- END -----

```



#### Function: Statistics

```

04.07.2007      10:44:07
ID              666
SNR:           1118015657
1              1100.15 g
2              1600.10 g
3              1699.95 g
n              3
x              1466.733 g
s              321.372 g
srel           21.91 %
min.          1100.15 g
max.          1699.95 g
dif.          599.80 g
----- END -----

```

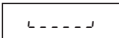
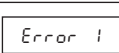
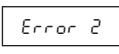
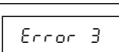
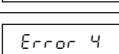
## 7.2 What if ...?

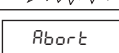
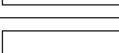
Error/Error message	Cause	Rectification
	Overload	→ Remove sample from weighing pan, zero again (tare).
	Underload	→ Check whether weighing pan is positioned properly.
	No stability <ul style="list-style-type: none"> <li>• in taring or adjusting (calibration)</li> <li>• when reference weight for piece counting is placed on pan</li> </ul>	<ul style="list-style-type: none"> <li>→ Wait for stability before pressing key.</li> <li>→ Ensure more stable ambient conditions.</li> <li>→ Remove weighing pan and clean if necessary</li> </ul>
	Wrong adjustment weight on pan or none at all	→ Place required adjustment weight in centre of pan.
	Reference weight (Piece counting, Percent weighing) too small	→ Increase reference weight.
	Internal fault	→ Contact METTLER TOLEDO customer service.
	Wrong weighing pan or pan missing or not empty	→ Place correct pan or empty pan on balance.
	Adjustment aborted with the «C» key	
	No display <ul style="list-style-type: none"> <li>• AC adapter not plugged in</li> <li>• Batteries discharged</li> </ul>	<ul style="list-style-type: none"> <li>→ Check AC power supply. Plug AC adapter into power supply.</li> <li>→ Replace batteries</li> </ul>



### 7.3 Maintenance and cleaning



#### Service

Regular servicing of your balance by a service technician prolongs its working life. Ask your METTLER TOLEDO dealer for details of servicing options.

#### Cleaning

Every now and then, clean the weighing pan, draftshield element, draftshield (depending on the model) and housing of your balance using a damp cloth. Your balance is made of high-quality, durable materials and can therefore be cleaned with a standard, mild cleaning agent.



#### Please observe the following notes

- On no account use cleaning agents, which contain solvents or abrasive ingredients, as this can result in damage to the terminal overlay.
- After working with chemicals, it is advisable to wash or clean the weighing pan and the bottom plate (if draft shield fitted).
- Although all materials are of high quality, corrosion may occur if corrosive substances are deposited on chrome steel for an extended period of time (and if air is excluded, for example by a coating of grease).
- Ensure that no liquid comes into contact with the balance or the AC adapter!
- Never open the balance or AC adapter – they contain no components, which can be cleaned, repaired or replaced by the user.
- Soiled protective covers can be replaced on all balance types (see Optional equipment).



#### Disposal

In conformance with the European Directive 2002/96/EC on Waste Electrical and Electronic Equipment (WEEE) this device may not be disposed of in domestic waste. This also applies to countries outside the EU, per their specific requirements. Please dispose of this product in accordance with local regulations at the collecting point specified for electrical and electronic equipment.

If you have any questions, please contact the responsible authority or the distributor from which you purchased this device.

Should this device be passed on to other parties (for private or professional use), the content of this regulation must also be related.

Thank you for your contribution to environmental protection.





## **GWP® – Good Weighing Practice™**

The global weighing guideline GWP® reduces risks associated with your weighing processes and helps to

- choose the appropriate balance
- reduce costs by optimizing testing procedures
- comply with the most common regulatory requirements

► [www.mt.com/GWP](http://www.mt.com/GWP)

[www.mt.com/jewelry](http://www.mt.com/jewelry)

For more information

### **Mettler-Toledo AG, Laboratory & Weighing Technologies**

CH-8606 Greifensee, Switzerland

Phone +41-44-944 22 11

Fax +41-44-944 30 60

[www.mt.com](http://www.mt.com)

Subject to technical changes.

© Mettler-Toledo AG 02/2011

11781164B 2.12



\* 1 1 7 8 1 1 6 4 \*